

3B SERIES AC & DC LOADS

Key features:

- Models from 1200 VA to 12600 VA
- High Voltage Range: 0 - 300 Vac/Vdc
- Current Ranges up to 126 A
- High-Speed 4 Digit Precision Metering Capability
- Parallel Operation for Higher Power Applications
- Single, Split or Three Phase Load Configurations
- Operating Modes: CC, Linear CC and CR
- Fast Current Slew Rates
- Go/NoGo Test Support
- Auto-Sequencing
- Bench Models 1200VA or 1800VA
- Higher Power Load Cabinets
- Standard RS232 and GPIB Interfaces



OVERVIEW

The ADAPTIVE POWER 3B Series Programmable DC Electronic Loads are ideally suited for testing AC power supplies, frequency converters, DC/AC inverters, Uninterruptable Power Supplies (UPS) and transformers. With their ability to support sinusoidal and non-sinusoidal AC voltage waveforms alike, the 3B Series loads can support a wide variety of AC test requirements.

Target applications for these loads are research & development, production test, incoming inspection, quality control and service.

The high power density of 1800VA in a 4U high, single 19" wide rack-mount chassis supports bench testing of most single phase AC products. The 3B Series consists of a total of two bench models and seven cabinet system configurations, providing a wide variation of possible current and power ranges. Starting at 1200 VA and ranging to 12600 VA cabinet systems, all models offer dual current range capability for optimal accuracy and resolution.

UTILITY, DEFENSE AND AVIONICS FREQUENCY SUPPORT

The 3B Series supports an AC frequency range from 40Hz to 400Hz. This covers testing at utility power frequencies for commercial and industrial power sources as well as at 400Hz avionics power for military, defense and commercial aviation power source testing.

GPIB

RS232

3B SERIES AC & DC LOADS

OPERATING MODES

All 3B Series loads support several modes of operation to accommodate different test requirements. Voltage sources like AC or DC power supplies are best tested using Constant Current (CC) or Constant Resistance (CR) mode.

The available operating modes are Constant Current, Linear Constant Current and Constant Resistance. A graphical representation of these modes of operation is shown here.

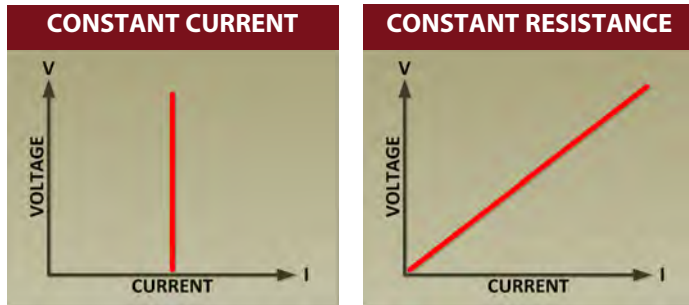

LINEAR CONSTANT CURRENT MODE

The Linear Constant Current mode differs from conventional CC load mode in that it uses a high bandwidth automatic gain control circuit to track changes in peak input voltage and provides near instantaneous load response. This mode of operation is particularly useful when working with voltage square waves, step waveforms or pulse shaped DC waveforms or with distorted AC sine waves resulting from high current crest factor load settings. The Linear CC mode greatly improves AC load current control compared to typical AC loads that lack this capability.

WIDE OPERATING RANGE

3B Series loads are designed to accommodate a wide range of voltage and current input combinations within their maximum power capability. This allows the same load to be used for higher voltage and low current requirements as well as low voltage higher current applications. The V-I operating curve for the 3B Series models is shown on the right.

The AC load continuously tracks its input voltage current and power and safeguards against any operation outside of its operating limits. This flexible operating range allows the same load module to be used for a wide range of EUTs.

MULTI-PHASE APPLICATIONS

For multi-phase applications such as split-phase or three-phase AC power source testing, two or three 3B Series AC loads may be used to create a Split, Delta or Wye AC load. Each phase is individually programmable and synchronized to its respective input voltage and the load current will be zero phase referenced. Note that for Delta load applications, the load modules are sensing line-to-line voltage and maximum AC input voltage is 300Vrms.

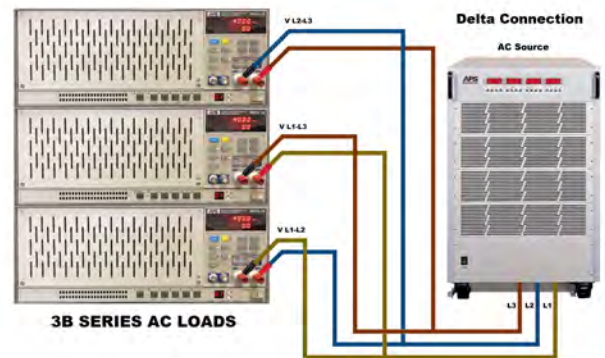
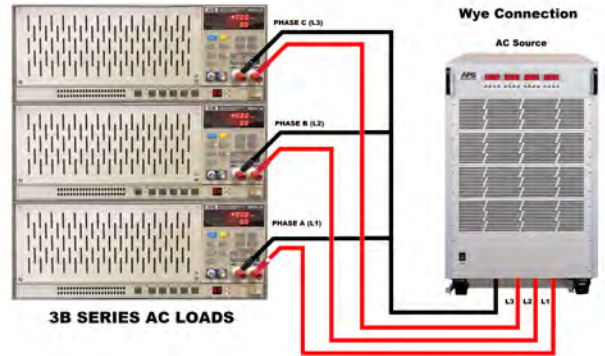

3B SERIES VI-CURVES

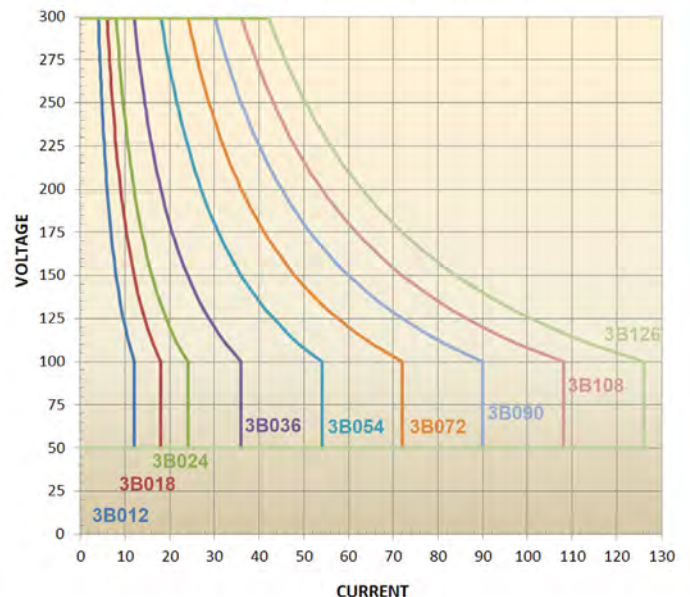

NON LINEAR LOADS

Many real world AC loads draw non-sinusoidal load currents. Typical examples are bridge rectified input circuits that convert AC voltage into DC. These are called non-linear load and the AC current resulting from these circuits has a crest factor higher than that of a pure sinusoidal current. The 3B Series loads can simulate these load conditions using a non-sinusoidal current waveform in CC mode. The phase angle between voltage and current in this mode of operation can be shifted to simulate leading or lagging displacement power factor conditions. The higher the crest factor of the current waveform selected, the wider the power factor can be varied. The waveforms on the right illustrate these load conditions.

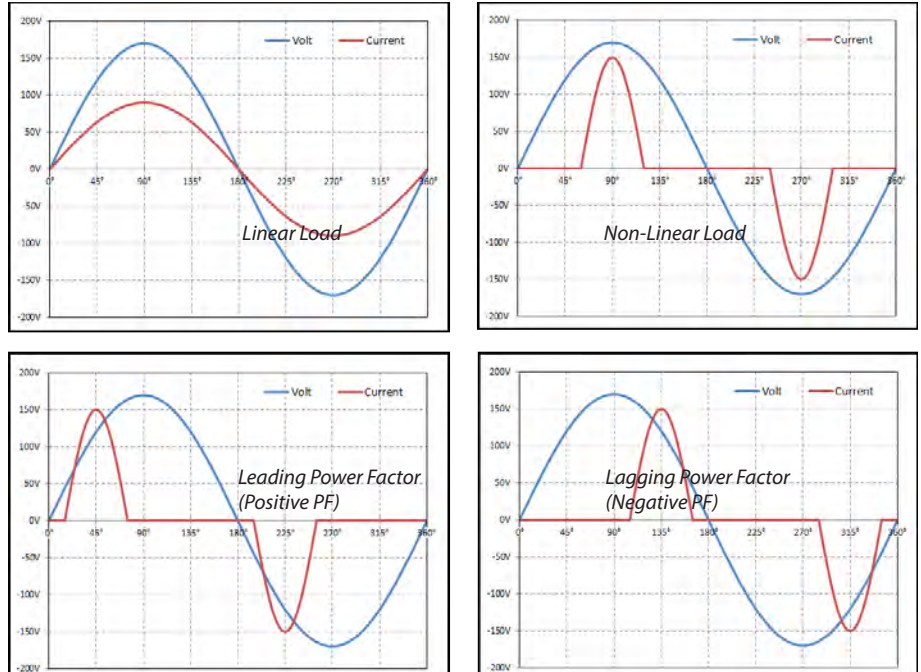

Linear and Non Linear Loads

STORED CF AND PF SETTINGS

Current crest factor (CF) and displacement power factor (PF) can be selected easily from the front panel or over bus by recalling preset combinations of CF and PF as function of waveform type. The table below shows these available settings. The relationship between available power factor and crest factor range is shown in the graph to the right for both leading and lagging power factor. If a sinusoidal load current is used (crest factor = $\sqrt{2}$), the power factor can only be +1.0 or =1.0. Displacement power factor less than one requires a load current with a higher crest than $\sqrt{2}$. Note that this requirement - which applies to all programmable AC Loads on the market - makes it not possible to simulate a pure inductive or capacitive AC load.

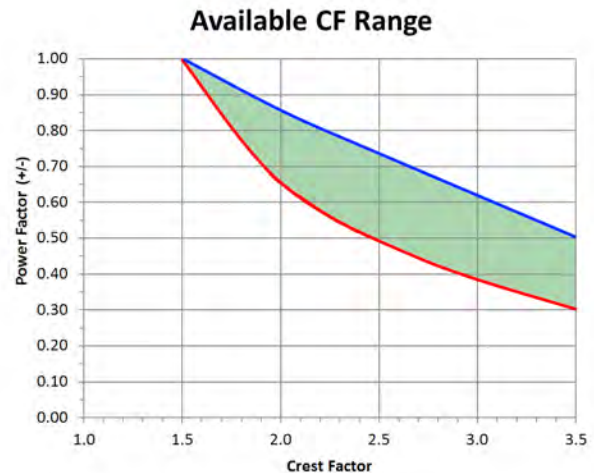

Waveform	Setting	A	B	C	D	E	Phase Shift
Sine wave	0	$\sqrt{2}$	2.0	2.5	3.0	3.5	
	1	1.5	1.6	1.7	1.8	1.9	
	2	3.0	3.1	3.2	3.3	3.4	
C.F. = 2	3	P.F. = -0.85	P.F. = -0.80	P.F. = -0.75	P.F. = -0.70	P.F. = -0.65	Lagging PF
C.F. = 2.5	4	P.F. = -0.75	P.F. = -0.70	P.F. = -0.65	P.F. = -0.50	P.F. = -0.40	
C.F. = 3.5	5	P.F. = -0.50	P.F. = -0.45	P.F. = -0.40	P.F. = -0.35	P.F. = -0.30	
C.F. = 2	6	P.F. = +0.85	P.F. = +0.80	P.F. = +0.75	P.F. = +0.70	P.F. = +0.65	Leading PF
C.F. = 2.5	7	P.F. = +0.75	P.F. = +0.70	P.F. = +0.65	P.F. = +0.50	P.F. = +0.40	
C.F. = 3.5	8	P.F. = +0.50	P.F. = +0.45	P.F. = +0.40	P.F. = +0.35	P.F. = +0.30	
Square	9	1.0	1.1	1.2	1.3	1.4	
DC	10	$\sqrt{2}$ dc	2 dc	2.5 dc	3.0 dc	3.5 dc	

3B SERIES AC & DC LOADS

FRONT PANEL OPERATION

3B Series AC & DC Loads are easily operated using the front panel keypad and bright red LED displays for ease of operation. Keys are clearly marked and setting are shown using LED indicators right next to their corresponding keys.

1. Model Number and ranges
2. Go/NoGo indicator illuminates if upper or lower limit settings are exceeded.
3. Operating Mode Indicators
4. REMOTE state indicator
5. Multi-purpose 5 digit display - Voltage and Power
6. Multi-purpose 5 digit display - Current and Apparent Power
7. Preset Mode ON/OFF Key Controls Readouts Shown on LED Display
8. LOAD ON/OFF button and indicator
9. WATT Display Mode ON/OFF Key

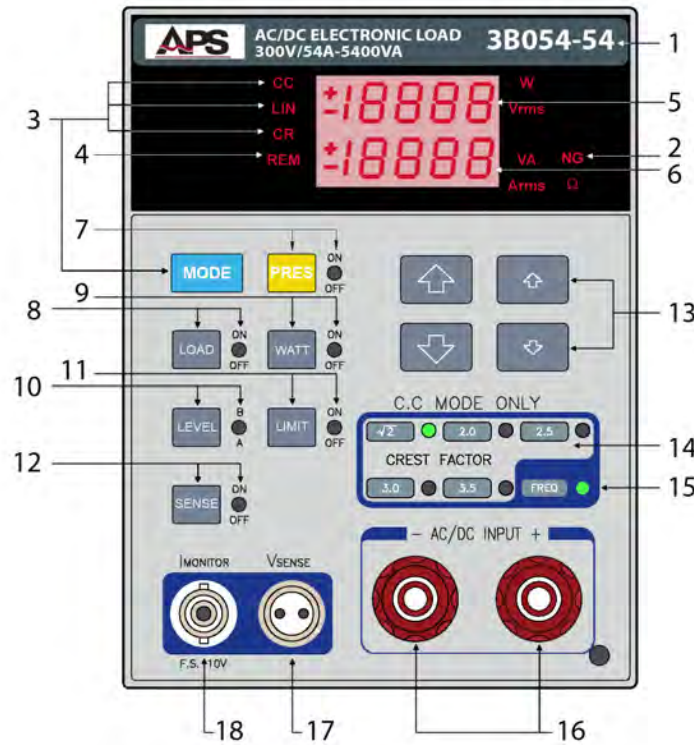

10. Level A/B Setting Toggle Key
11. Limit Mode ON/OFF and LED Readout Key
12. Internal or External Voltage Sense Mode Selection Key
13. Rough and Fine Setting Adjustment UP/DOWN Keys
14. Crest Factor Selection Keys
15. Frequency, BANK and SYNC Settings Key
16. Load Input Terminals
17. External Voltage Sense Connector
18. Current Monitor Output BNC

REAR PANEL

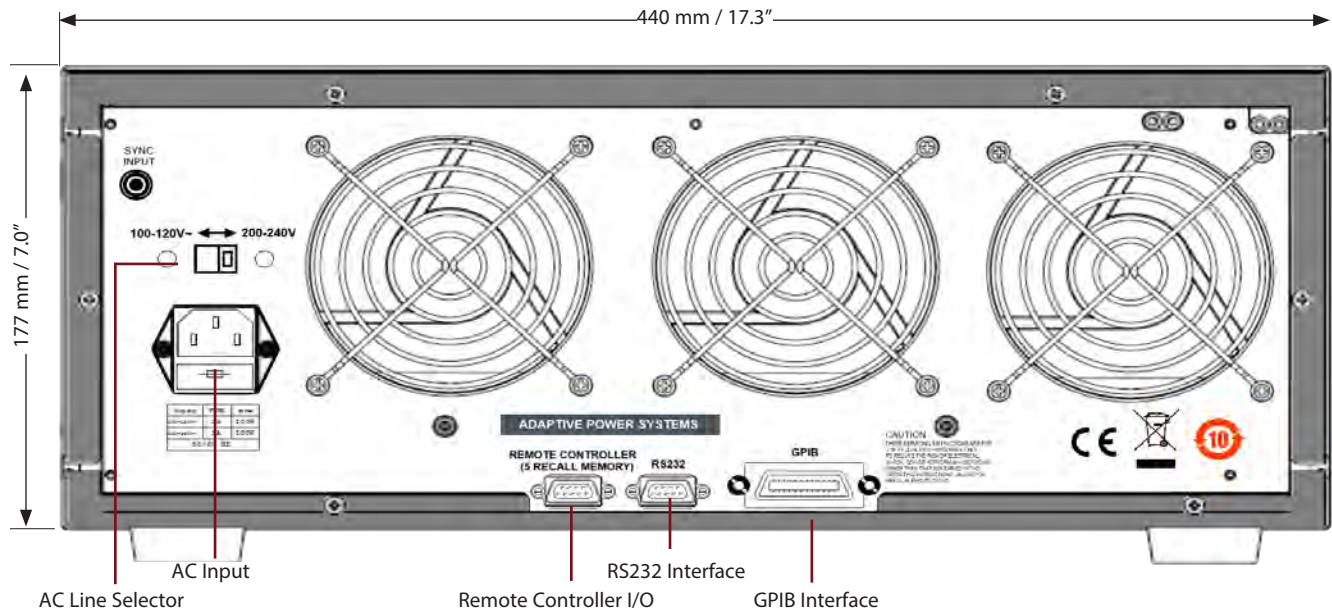

SPECIFICATIONS

MODEL	3B012-12		3B018-18		3B024-24		3B036-36		3B054-54	
OPERATING RANGES										
Power Ranges	0 - 1200 VA		0 - 1800 VA		0 - 2400 VA		0 - 3600 VA		0 - 5400 VA	
Current Ranges	0 - 6 A	6 - 12 A	0 - 9 A	9 - 18 A	0 - 12 A	12 - 24 A	0 - 18 A	18 - 36 A	0 - 27 A	27 - 54 A
Voltage Range	50 - 300 Vrms/Vdc		50 - 300 Vrms/Vdc		50 - 300 Vrms/Vdc		50 - 300 Vrms/Vdc		50 - 300 Vrms/Vdc	
Frequency	DC, 40 - 400Hz (CC Mode) / DC - 400Hz (LIN,CR Mode)									
AC Waveforms	Sine, Square, Step, DC									
OPERATING MODES										
CC Mode - High Range	0 - 6 A	6 - 12 A	0 - 9 A	9 - 18 A	0 - 12 A	12 - 24 A	0 - 18 A	18 - 36 A	0 - 27 A	27 - 54 A
Resolution	1.5 mA	3.0 mA	2.25 mA	4.5 mA	3.0 mA	6.0 mA	4.5 mA	9.0 mA	6.75 mA	13.5 mA
Accuracy	50Hz & 60Hz: $\pm 0.5\%$ OF (SETTING + RANGE) / > 60 Hz: $\pm(0.5\%$ OF SETTING + 1% OF RANGE)									
CC Mode - Low Range	0 - 0.6 A		0 - 0.9 A		0 - 1.2 A		0 - 1.8 A		0 - 2.7 A	
Accuracy	$\pm 2\%$ OF (SETTING + RANGE)									
CC Linear Mode	Refer to CC Mode data									
Crest Factor Mode Range	$\sqrt{2} - 3.5 / 1.5 - 1.9 / 3.0 - 3.4$									
Resolution	0.5 / 0.1 / 0.1									
Lagging	-0.30 to -0.85 for CF 2.0 to 3.5									
Leading	+0.30 to +0.85 for CF 2.0 to 3.5									
CR Mode Range	5 - 20 Ω	20 - 80k Ω	3.333 - 13.33 Ω	13.33 - 33.33k Ω	2.5 - 10 Ω	10 - 40 k Ω	1.667 - 6.668 Ω	6.668 - 26.668k Ω	1.111 - 4.444 Ω	4.444 - 17.776k Ω
Resolution ⁽¹⁾	0.052 mS	0.013 mS	0.076 mS	0.019 mS	0.1 mS	0.025 mS	0.148 mS	0.037 mS	0.224 mS	0.056 mS
Accuracy	50Hz & 60Hz: $\pm 0.5\%$ OF (SETTING + RANGE) / > 60 Hz: $\pm(0.5\%$ OF SETTING + 2% OF RANGE)									
PROTECTION										
Over Power (OP)	1260 VA		1890 VA		2520 VA		3780 VA		5570 VA	
Over Current (OC)	12.6 A		18.9 A		25.2 A		37.8 A		25.7 A	
Over Voltage (OV)	315 V									
Over Temperature (OT)	+85° C / +185° F									
CREST & POWER FACTOR RANGE										
Lagging PF	CF: $\sqrt{2}$ to 3.5 . PF: - 0.30 to -0.85									
Leading PF	CF: $\sqrt{2}$ to 3.5 . PF: + 0.30 to +0.85 or 1.00									
METERING										
Voltage Range	0 - 300 V									
Resolution	0.1 V									
Accuracy	$\pm(0.5\%$ OF SETTING + 0.2% OF RANGE)									
Current Range	0 - 12 A		0 - 18 A		0 - 24 A		0 - 36 A		0 - 54 A	
Resolution	0.001 A		0.001 A		0.01 A		0.01 A		0.012 A	
Accuracy	50Hz & 60Hz: $\pm 0.5\%$ OF (READING + RANGE) / > 60 Hz: $\pm(0.5\%$ OF READING + 2% OF RANGE)									
Power Range	0 - 1200 W		0 - 1800 W		0 - 2400 W		0 - 3600 W		0 - 5400 W	
Resolution	0.1 W		0.1 W		0.1 W		1 W		1.2 W	
Accuracy	50Hz & 60Hz: $\pm 0.5\%$ OF (READING + RANGE) / > 60 Hz: $\pm(0.5\%$ OF READING + 2% OF RANGE)									
Apparent Power Range	0 - 1200 VA		0 - 1800 VA		0 - 2400 VA		0 - 3600 VA		0 - 2400 VA	
Resolutions	0.1 VA		0.1 VA		0.1 VA		1 VA		1.2 VA	
Accuracy	Derived from Volt and Current Measurement									
OTHER SPECIFICATIONS										
Current Monitor Out	3 A/V		4.5 A/V		6 A/V		9 A/V		13.5 A/V	
Accuracy	$\pm 0.5\%$ OF (SETTING + RANGE)									
GENERAL										
AC Input	100/115 $\pm 10\%$ or 200/230V $\pm 10\%$, 50/60 Hz									
Cooling	Variable speed fan, front air intake, rear exhaust									
Dimensions (H x D x W)	177 x 445 x 440 mm / 7.0" x 17.5" x 17.3"					839 x 600 x 600 mm / 33.0" x 23.6" x 23.6"				
Weight (Net)	18.5 kg / 40.8 lbs		21.5 kg / 47.4 lbs		77.0 kg / 169.8 lbs		77.0 kg / 169.8 lbs		98.5 kg / 217.2 lbs	
Operating Temp. Range	0 - 40° C / 32 - 104° F									
EMC & Safety	CE Mark									

Note 1: S = Siemens or mho, unit of conductance. 1S = 1/ Ω = A/V.

3B SERIES AC & DC LOADS

SPECIFICATIONS

MODEL	3B072-72		3B090-90		3B108-108		3B126-126		
OPERATING RANGES									
Power Ranges	0 - 7200 VA		0 - 9000 VA		0 - 10800 VA		0 - 12600 VA		
Current Ranges	0 - 36 A	36 - 72 A	0 - 45 A	45 - 90 A	0 - 54 A	54 - 108 A	0 - 63 A	63 - 126 A	
Voltage Range	50 - 300 Vrms/Vdc		50 - 300 Vrms/Vdc		50 - 300 Vrms/Vdc		50 - 300 Vrms/Vdc		
Frequency	DC, 40 - 400Hz (CC Mode) / DC - 400Hz (LIN,CR Mode)								
AC Waveforms	Sine, Square, Step, DC								
OPERATING MODES									
CC Mode - High Range	0 - 36 A	36 - 72 A	0 - 45 A	45 - 90 A	0 - 54 A	54 - 108 A	0 - 63 A	63 - 126 A	
Resolution	9 mA	18 mA	11.25 mA	21.5 mA	13.5 mA	27 mA	15.75 mA	31.5 mA	
Accuracy	50Hz & 60Hz: $\pm 0.5\%$ OF (SETTING + RANGE) / > 60 Hz: $\pm(0.5\%$ OF SETTING + 1% OF RANGE)								
CC Mode - Low Range	0 - 3.6 A		0 - 4.5 A		0 - 5.4 A		0 - 6.3 A		
Accuracy	$\pm 2\%$ OF (SETTING + RANGE)								
CC Linear Mode	Refer to CC Mode data								
Crest Factor Mode Range	$\sqrt{2} - 3.5 / 1.5 - 1.9 / 3.0 - 3.4$								
Resolution	0.5 / 0.1 / 0.1								
Lagging	-0.30 to -0.85 for CF 2.0 to 3.5								
Leading	+0.30 to +0.85 for CF 2.0 to 3.5								
CR Mode Range	0.833-3.333 Ω	3.333-13.33k Ω	0.666-2.666 Ω	2.666-10.666k Ω	0.556-2.224 Ω	2.224-8.888k Ω	0.476-1.904 Ω	1.904-7.616k Ω	
Resolution ⁽¹⁾	0.300 mS	0.075 mS	0.375 mS	0.094 mS	0.452 mS	0.113 mS	0.525 mS	0.131 mS	
Accuracy	50Hz & 60Hz: $\pm 0.5\%$ OF (SETTING + RANGE) / > 60 Hz: $\pm(0.5\%$ OF SETTING + 2% OF RANGE)								
PROTECTION									
Over Power (OP)	7560 VA		9450 VA		11340 VA		13230 VA		
Over Current (OC)	75.6 A		94.5 A		113.4 A		132.3 A		
Over Voltage (OV)	315 V								
Over Temperature (OT)	+85° C / +185° F								
CREST & POWER FACTOR RANGE									
Lagging PF	CF: $\sqrt{2}$ to 3.5 . PF: - 0.30 to -0.85								
Leading PF	CF: $\sqrt{2}$ to 3.5 . PF: + 0.30 to +0.85 or 1.00								
METERING									
Voltage Range	0 - 300 V								
Resolution	0.1 V								
Accuracy	$\pm(0.5\%$ OF SETTING + 0.2% OF RANGE)								
Current Range	0 - 72 A		0 - 90 A		0 - 108 A		0 - 126 A		
Resolution	0.012 A		0.012 A		0.012 A		0.014 A		
Accuracy	50Hz & 60Hz: $\pm 0.5\%$ OF (READING + RANGE) / > 60 Hz: $\pm(0.5\%$ OF READING + 2% OF RANGE)								
Power Range	0 - 7200 W		0 - 9000 W		0 - 10800 W		0 - 12600 W		
Resolution	1.2 W		1.2 W		1.2 W		1.2 W		
Accuracy	50Hz & 60Hz: $\pm 0.5\%$ OF (READING + RANGE) / > 60 Hz: $\pm(0.5\%$ OF READING + 2% OF RANGE)								
Apparent Power Range	0 - 7200 VA		0 - 9000 VA		0 - 10800 VA		0 - 12600 VA		
Resolutions	1.2 VA		1.2 VA		1.2 VA		1.2 VA		
Accuracy	Derived from Volt and Current Measurement								
OTHER SPECIFICATIONS									
Current Monitor Out	18 A/V		22.5 A/V		27 A/V		31.5 A/V		
Accuracy	$\pm 0.5\%$ OF (SETTING + RANGE)								
GENERAL									
AC Input	100/115 $\pm 10\%$ or 200/230V $\pm 10\%$, 50/60 Hz								
Cooling	Variable speed fan, front air intake, rear exhaust								
Dimensions (H x D x W)	1283 x 600 x 600 mm / 50.5" x 23.6" x 23.6"				1506 x 600 x 600 mm 59.3" x 23.6" x 23.6"		1728 x 600 x 600 mm 68" x 23.6" x 23.6"		
Weight (Net)	153 kg / 337.3 lbs		174.5 kg / 384.7 lbs		196 kg / 432.1 lbs		230.5 kg / 508.2 lbs		
Operating Temperature Range	0 - 40° C / 32 - 104° F								
EMC & Safety	CE Mark								

Note 1: S = Siemens or mho, unit of conductance. 1S = 1/ Ω = A/V.

3B SERIES CABINETS



Model 3B126-126 AC Load Cabinet System



Model 3B126-126 Rear View

3B SERIES AC & DC LOADS

ORDERING INFORMATION:

Line 1: Specify DC Load Model:

3B0xx-xx Chassis or Cabinet System

Line 2: Specify Load Cable Option. (See Table)

Available Load Cable Options:

Option P/N	Description	MOQ
OPT-C1KA1	Load Cable, 1000A rated, 1 meter	2
OPT-C1KA2	Load Cable, 1000A rated, 2 meter	2
OPT-C1KA3	Load Cable, 1000A rated, 3 meter	2
OPT-C1KA4	Load Cable, 1000A rated, 4 meter	2
OPT-C1KA5	Load Cable, 1000A rated, 5 meter	2

AC Input Voltage

Please specify AC Line input voltage at the ship-to location on the order as either 120Vac or 230Vac.

Included in Mainframe Ship kit:

- User Manuals in PDF Format on CD ROM.
- AC Line Cord.
- Rack Handles (detached).
- Voltage Sense Input Cable (V_{SENSE})
- BNC Cables, 3 feet (2), I-Monitor & Ext. Sync.
- Banana Jack, Red
- Banana Jack, Black
- Spade Lugs (2)
- Certificate of Conformance.

Service and Support

Adaptive Power Systems' customer support is second to none. Our Customer Support Program provides the training, repair, calibration, and technical support services that our customers value. So, in addition to receiving the right test equipment, our customers can also count on excellent support before, during and after the sale. With company owned support and service centers around the world, support is never far away.

Complete calibration and repair services are offered at our US, European and Chinese manufacturing facilities (see contact info below). Calibrations are to original factory specifications and are traceable to NIST (National Institute of Standards and Technology).

NORTH AMERICA

Adaptive Power Systems
Irvine, USA
Phone: +1 (949) 752-8400
Fax: +1 (949) 756-0838
Email: support@adaptivepower.com

EUROPE

Caltest Instruments Ltd.
Guildford, United Kingdom
Phone: +44(0)1483 302 700
Fax: +44(0)1483 300 562
Email: support@adaptivepower.com

CHINA

PPST Shanghai Co. Ltd.
Shanghai, China
Phone: +86-21-6763-9223
Fax: +86-21-5763-8240
Email: support@adaptivepower.com

NEED HELP?

 sales@adaptivepower.com
 OR CALL
 Toll Free: +1 (866) 517-8400
 Intl: +1 (949) 752-8400



Proudly Represented by:



Caltest Instruments GmbH

Kohlmattstrasse 7 | Tel: +49(0)7842-99722-00
D-77876 KAPPELRODECK | Fax: +49(0)7842-99722-29
info@caltest.de | www.caltest.de



ADAPTIVE POWER SYSTEMS

17711 Mitchell North
Irvine, CA 92614
United States
Toll Free: 1.866.517-8400
Tel: +1.949.752-8400
Fax: +1.949.756-0838